

RPR-EPON-WiMAX Hybrid Network: A Solution for Access and Metro Networks

Abdou Ahmed and Abdallah Shami

Abstract—The integration of Ethernet passive optical networks (EPONs) with wireless worldwide interoperability for microwave access (WiMAX) is an approved solution for an access network. A resilient packet ring (RPR) is a good candidate for a metro network. Hence RPR, EPON, and WiMAX integration is a viable solution for metro-access network bridging. The present paper examines such integration, including an architecture and a joint media access control (MAC) protocol, as a solution for both access and metro networks. The proposed architecture is reliable due to the dependability of the RPR standard and the protection mechanism employed in the EPON. Moreover, the architecture contains a high fault tolerance against node and connection failure. The suggested MAC protocol includes a multi-level dynamic bandwidth allocation algorithm, a distributed admission control, a scheduler, and a routing algorithm. This MAC protocol aims at maximizing the advantages of the proposed architecture by distributing its functionalities over different parts of the architecture and jointly executing the parts of the MAC protocol.

Index Terms—Admission control; Bandwidth allocation; EPON; Hybrid network; MAC protocol; QoS; Routing; RPR; Scheduler; Simulation; WiMAX.

I. INTRODUCTION

The resilient packet ring (RPR) possesses features that make it a promising candidate for building high-performance metro edges and metro core rings interconnecting multiple access networks [1]. Integration between an Ethernet passive optical network (EPON) and worldwide interoperability for microwave access (WiMAX) networks is considered a promising solution for access networks [2,3]. Hence the combination of an RPR with an EPON and WiMAX can be considered as a solution not only for access networks but also for connecting an access network to metro networks. In [4], we considered an optical-wireless hybrid network as the integration between EPON and WiMAX networks. Specifically, we proposed an architecture for an EPON-WiMAX hybrid network which is reliable and immune to failures. Moreover, we proposed a media access control (MAC) protocol for the proposed architecture.

In [4], the network architecture was made reliable in the optical part by duplicating the functionality of the root nodes, the optical line terminal (OLT) of the EPON. The leaf

nodes in each segment of the architecture, the subOLT or the optical network unit (ONU), are dually connected to root nodes, the OLT or the subOLT, respectively. In the present work, the integration between the two known standards, RPR and EPON, can provide the desired reliability for the optical part in the hybrid network. In the present work, we consider an optical-wireless hybrid network that employs an integrated RPR-EPON as an optical backhaul network and WiMAX as a front-end network. This configuration will form the RPR-EPON-WiMAX hybrid network. Accordingly, we propose both the architecture and the MAC protocol for the RPR-EPON-WiMAX hybrid network. The proposed MAC protocol aims to maximize the advantages of the suggested architecture and to provide end-to-end quality of service (QoS) for streams over the network. In order to achieve the desired target, the MAC protocol distributes its functionalities over the parts of the architecture. Moreover, parts of the MAC protocol are executed jointly with the routing algorithm.

A. Contributions of This Work

We consider the reliability of an RPR-EPON-WiMAX network. We also propose a MAC protocol for both upstream and downstream directions that ensures and protects the end-to-end QoS of all connections of all service types. More specifically, the contributions of this paper can be summarized as follows:

- (1) It proposes a new reliable architecture for a hybrid RPR-EPON-WiMAX network.
- (2) It proposes a service type based scheduler in both the EPON and the WiMAX network and maps the specified classes in the RPR to the service types defined in the WiMAX network.
- (3) It proposes an admission control (AC) which is concerned with the network state and sets the WiMAX frame duration and/or the EPON cycle time dynamically.
- (4) It presents a dynamic bandwidth allocation (DBA), which ensures the end-to-end per-connection QoS guarantee.

The remainder of this paper is organized as follows. Section II provides a review of related work. The proposed RPR-EPON-WiMAX based hybrid network architecture is presented in Section III. In Section IV, a routing mechanism for the proposed architecture is explained. Our proposed joint MAC protocol is presented in Section V. A performance evaluation of the proposed architectures and joint MAC scheme is presented in Section VI. Finally, Section VII concludes this work and outlines possibilities for future work.

Manuscript received April 1, 2011; revised December 27, 2011; accepted January 5, 2012; published February 13, 2012 (Doc. ID 145116).

The authors are with the Department of Electrical and Computer Engineering, The University of Western Ontario, London, ON, N6A 5B9 Canada (e-mail: aahmed84@uwo.ca).

Digital Object Identifier 10.1364/JOCN.4.000173

II. RELATED WORKS

As RPR–EPON–WiMAX integration has not yet been examined, we reviewed the literature for existing EPON–WiMAX and RPR–EPON combinations.

A. EPON–WiMAX Hybrid Networks

EPON–WiMAX networks have been considered in many works, and architectures, bandwidth allocations, and schedulers have been proposed for these networks.

1) *Architectures*: Architectures that connect an EPON and a WiMAX network in a straightforward fashion, but pay more attention to how WiMAX base stations (BSs) are integrated with EPON ONUs, were proposed in [2]. These architectures include independent architectures, hybrid architectures, unified connection-oriented architectures, and microwave-over-fiber (MoF) architectures.

Integration of an EPON and a WiMAX network in a large WiMAX network that transmits its data over a passive optical network to the backbone network was first described in [5,6]. The functionality of the central controller for the whole WiMAX is divided between the BS and the OLT.

Other types of optical–wireless access networks were also proposed in [7,8]. In these architectures, BSs can be attached directly to gateways/ONUs and their data sent over an ONU. Alternatively, BSs can be connected to gateways over other intermediate wireless BSs by taking advantage of wireless mesh networking. For these architectures, the authors mainly discussed the issues of routing, load balancing, packet forwarding, and BS placement.

2) *MAC Protocol*: In [9], the authors propose a joint admission control (AC) and DBA method, but only to admit and maintain virtual private networks (VPNs) over an EPON–WiMAX network.

To date, a few scheduling mechanisms have been proposed to support QoS and improve performance for delay-sensitive traffic in EPON–WiMAX networks [5,10,11]. But these scheduling mechanisms are remote station based mechanisms and consider scheduling in the WiMAX network and the EPON separately.

Additional bandwidth allocation algorithms for EPON–WiMAX networks have been proposed in [3,12,13]. In QoS-based dynamic bandwidth allocation (QDBA) [12], each ONU is in charge of three queues with different priorities. QDBA also classifies WiMAX traffic into three priority levels and maps them to the queues of the ONU. The DBA scheme proposed in [3] considers the features of the converged network proposed in the same paper to enable a smooth data transmission across optical and wireless networks and an end-to-end differentiated service to user traffic with diverse QoS requirements. Bandwidth allocation and the support of different service flows in [13] modifies the EPON MAC layer mechanism to adopt a connection-oriented MAC layer structure implemented in the WiMAX network.

None of these bandwidth allocations (BAs) have a mechanism to support all the service types defined in WiMAX standards over the hybrid access network. Moreover, these BAs do

not guarantee end-to-end QoS of traffic as they manage bandwidth allocation in the WiMAX network and the EPON separately, and there is no direct mapping between the two BAs.

B. RPR–EPON Networks

The papers [14,15] have employed RPR and EPON integration as an optical backhaul network in core and edge metro networks. The integration is proposed in an architecture called STARGATE in [14] and a very similar architecture called SuperMAN in [15].

1) *Architectures*: The STARGATE architecture in [14] consists of an RPR metro edge ring that interconnects multiple wavelength-division multiplexing (WDM) EPON tree networks to each other as well as to the Internet and server farms. For STARGATE, the authors explore the merits of connecting the OLT with a subset of ONUs using an additional point-to-point (P2P) or point-to-multipoint (PMP) fiber link. In particular, STARGATE consists of central offices (COs), which are interconnected via a single-hop WDM star subnetwork, and RPR ring nodes.

In [15], the authors employ the same architecture as that proposed in [14]; however, they extend the ring part of the architecture by an optical–wireless interface that connects with the WiMAX networks, and they detail the node located at the optical–wireless RPR–WiMAX interface.

2) *MAC Protocol*: In [14], the authors proposed to alter the discovery and registration operations in a WDM EPON according to the modification described in [16] in order to manage STARGATE. Although the authors do not propose any DBA algorithm for STARGATE, they specify the required characteristics of the DBA algorithm.

In [15], the authors are not concerned about the MAC protocol of the RPR–EPON. Instead, they focus on the MAC of the PRP–WiMAX integration. Specifically, they have proposed an integrated hierarchical scheduler that maps RPR traffic classes to WiMAX scheduling services and provides end-to-end QoS connectivity.

III. PROPOSED RPR–EPON–WiMAX NETWORK ARCHITECTURE

As far as we know, RPR, EPON, and WiMAX integration has not yet been considered. However, the integration between an RPR and an EPON has been studied for core and edge metro networks. Furthermore, as a solution for the access network, EPON–WiMAX integration has been proposed in many works. Nevertheless, the reliability of the EPON–WiMAX hybrid network is insufficient, especially for node and connection failure in the EPON part. Moreover, it may be desirable to extend the coverage area of the EPON–WiMAX hybrid network. In addition, the reliability of the EPON part of the network needs to be improved in order to attain the desired level of reliability of the entire network. In fact, all of the desired features are achieved in the present proposed architecture, which is explained in the following subsections.

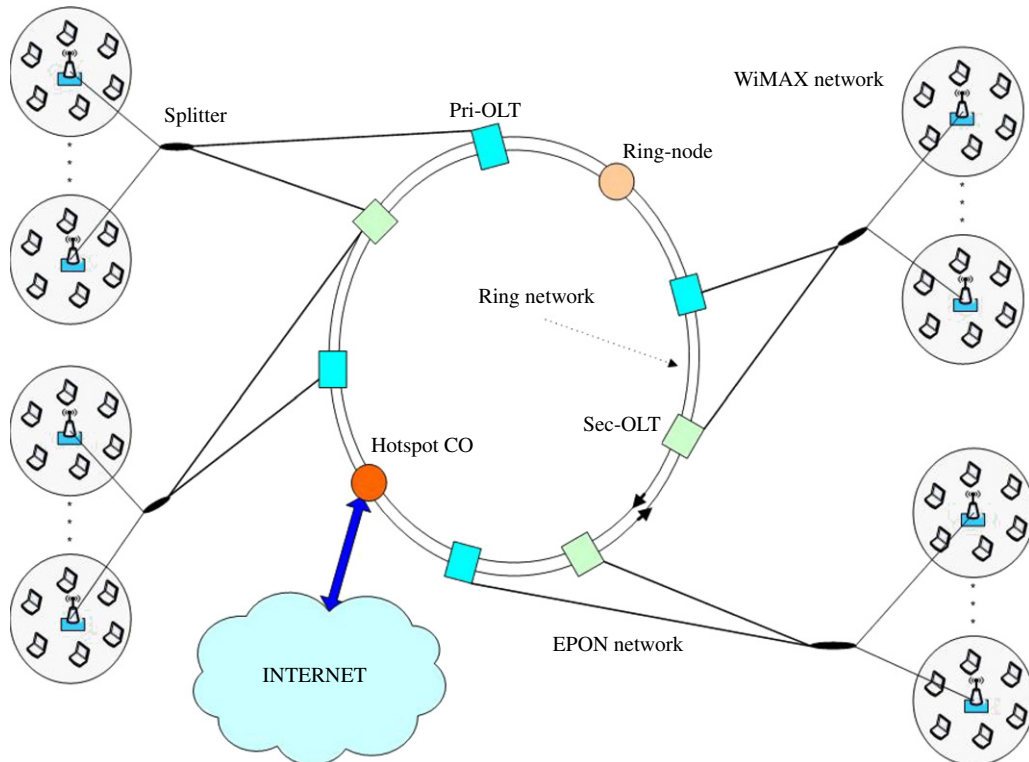

Fig. 1. (Color online) RPR-EPON-WiMAX network architecture.

A. Proposed Architecture

Our proposed architecture for the RPR-EPON-WiMAX hybrid network is shown in Fig. 1. The front end of the architecture includes a group of WiMAX networks that are served by the backhaul optical network. The optical part of the architecture consists of many EPON segments that are rooted at the RPR ring network. In fact, the optical part of our architecture is similar to the STARGATE network architecture proposed in [14]; however, our architecture does not include the star subnetwork, as it aims to measure the performance of the network based on the RPR standard reliability. Moreover, the star subnetwork in STARGATE aims to minimize the delay in the ring network, while, in the present proposed architecture, the delay results from the WiMAX part. Thus, network performance is not improved by decreasing the delay of the ring network.

B. Architecture Reliability

The proposed architecture is composed of the RPR, EPON, and WiMAX parts. The RPR is reliable against any one node or two connector failures. The WiMAX network has no channel disconnection, as its channel can experience service degradation for certain periods of time. Moreover, node failure in the WiMAX network can be partially compensated for by user mobility, especially when the BS fails. However, if a traditional EPON segment is used in the architecture, a large portion of the architecture will be disconnected in the case of

an OLT or feeder fiber failure, especially as the feeder fiber connects the OLT to the splitter. Due to the presence of the EPON part, the entire architecture is not immune against one node or connection failure. Hence, we need to make the EPON part reliable against OLT or feeder fiber failure in order to improve the reliability of the architecture.

The reliability of the EPON part can be improved by connecting the splitter of each EPON segment to two OLT nodes on the ring. This solution can be easily achieved by connecting the splitter of each EPON segment through a second feeder fiber to the OLT of one of the two adjacent segments. However, there are two possible drawbacks to this solution. First, the process of installing fiber connections across EPON segments can be costly, as the distance between EPON segments is normally significant. Second, when users of the two segments are served through one OLT in the case of failure, the QoS granted to these users is adversely affected. Hence, we will have to accept QoS degradation in the case of failure or we should keep the segments lightly loaded during normal operation.

In order to reduce the cost of fiber installation and prevent QoS degradation, redundant OLT nodes, known as Sec-OLTs, are employed on the ring, as demonstrated in Fig. 1. One Sec-OLT can be employed for each EPON segment, or, if the distance is reasonable, a single sec-OLT can serve two segments. As discussed in subsequent sections, redundant nodes can be used for large distances between OLTs on the ring; Sec-OLTs can replace these nodes while also performing their original job.

C. Architecture Elements Structure in an RPR-EPON-WiMAX Network

In the proposed architecture, the subscriber station (SS) is a standard WiMAX SS. The structures of both the WiMAX BS and the EPON ONU differ according to the integration method between the WiMAX network and the EPON (see [2] for details.)

In the proposed architecture, all splitters are $2 \times N$, where N is the number of ONU/BS nodes in the EPON segment. However, the OLT structure in the EPON network is different from that in the EPON-WiMAX network, as will be explained later.

The RPR ring network in the architecture has three types of node: the ring node, the hotspot central office (HCO) node, and the OLT node. The structures of these nodes are discussed in the following section.

Ring Node Structure: The ring node is the standard RPR node. Every ring node is equipped with two fixed-tuned transmitters (FTs) and two fixed-tuned receivers (FRs), one for each ring. Both the FT and the FR operate at the single wavelength channel of the corresponding ring. Each ring node has separate transit and station queues for either ring. For each direction, a ring node has four types of queue [1]. First, one set of transmit queues holds data packets from the node itself until it has the opportunity to transmit these packets over the ring. Specifically, this set of queues includes a stage queue and three class queues, one of which is for each service class defined in the RPR standard: A, B, and C. Second, there are one or two transit queues for storing the data packets received from the other nodes before they are injected into the ring. In the case of two transit queues, the traffic of Class A is buffered in the primary transit queue (PTQ), while Class B and Class C traffic are buffered in the secondary transit queue (STQ). Third, a receive queue holds received data packets for the node before sending them to the client. Fourth, there is one queue for the MAC control packets from the node itself as well as from other nodes.

Ring nodes are optional in the architecture: they are only employed to extend the coverage area of the network. Generally, they are used when a significant distance exists between two OLTs and a repeater is needed. However, the replacement of repeaters with ring nodes provides the architecture with sufficient scalability.

Hotspot Central Office: An HCO has the same structure as a ring node. In addition, an HCO has an additional functionality to connect the ring network to the Internet through a router; however, this process is not shown in Fig. 1.

OLT Node Structure: An OLT node functions similarly to both a ring node and an OLT in EPONs. Each OLT node is equipped with the same transceivers and queues as a ring node. In addition, each OLT has at least one transceiver and one queue set that is needed to communicate with the ONUs of the EPON segment. Hence, an OLT is equipped with an array of fixed-tuned transmitters and fixed-tuned receivers, respectively operating at the downstream and upstream

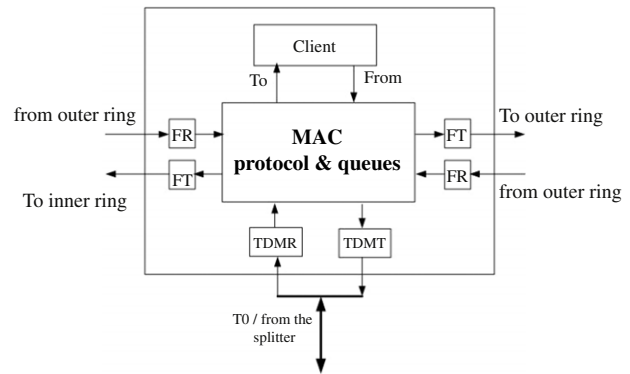

Fig. 2. OLT node structure.

wavelength channels of the EPON. An OLT can have one tunable/time-division multiplexing (TDM) receiver and one tunable/TDM transmitter to communicate with all ONUs over the feeder fiber connection. Accordingly, Fig. 2 shows the structure of an OLT node with a TDM receiver and transmitter.

The queue structure is depicted in Fig. 3. In particular, this figure shows the selection of both the path and the queue for the OLT node with two transit queues: the PTQ and the STQ. In addition to the queues of the ring node, the OLT node has a set of queues corresponding to ONUs, which will be explained in Subsection V.C. This figure only shows the queues that are necessary for this particular process. For instance, if packets are stored in the transmit queues, the classes' queues are shown; otherwise, only the stage queue is illustrated.

Depending on the routing mechanism, the packet received from the client can be directed to transmit queues of one ring direction, especially if it is destined for another OLT/ring node. If the packet received from the client is destined for an ONU, it is put in one of the ONU queues on the basis of its destination and priority type. Any packet received from the ring can be put in the receive queue, ONU queues, or one of the transit queues, depending on whether its destination is the node itself, an ONU, or another OLT/ring node, respectively. Also, a packet arriving from an ONU is put into the receive queue or directed to the transmit queues depending on whether the packet's destination is the node itself or another OLT/ring node. If this packet is not destined for the node, it is put in the transmit queues of one ring direction, depending on the routing mechanism.

D. Architecture Discovery

As in the case of the RPR standard, a protocol that provides nodes on the RPR ring with the ability to build and maintain an image of the network topology is needed. The architecture discovery protocol is based on the topology discovery message that is periodically broadcast by all nodes on the ring according to the RPR standard. The discovery message in the RPR standard includes the following information:

- Information that enables each node to determine the relative position of the sending node.

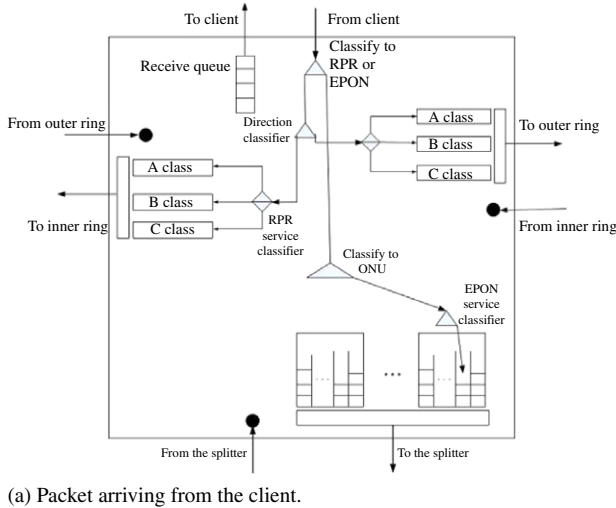

(a) Packet arriving from the client.

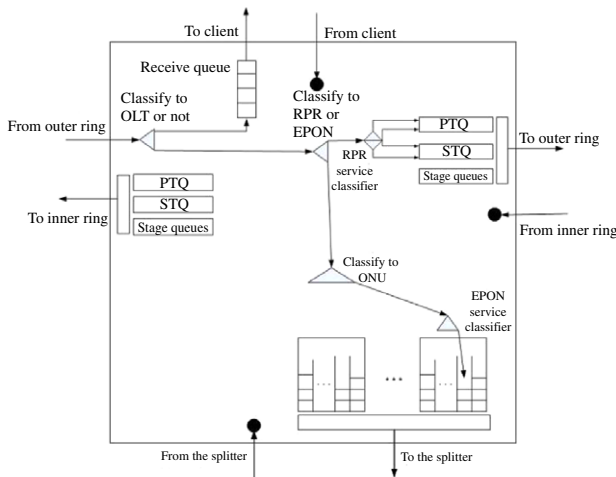

(b) Packet arriving from the outer ring.

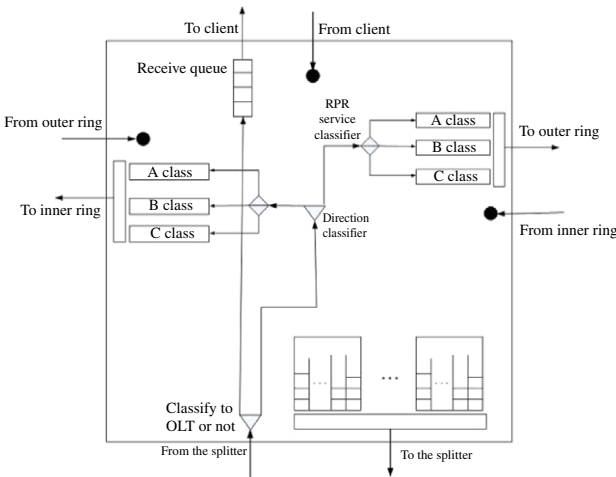

(b) Packet arriving from the EPON.

Fig. 3. Path and queue selection of an OLT node.

- Status information about the sending node; this indicates whether it is working or failing.
- Information about the node bandwidth allocation.

- Information about any link or node failure detected by the source node.

The topology discovery message is sent immediately when a new node is inserted into the ring or when a node detects a failure at its links or neighboring nodes. Otherwise, this message is sent periodically. Additionally, a node sends a topology discovery message if it receives another such message that is inconsistent with the information in its database.

In our architecture, the topology discovery message issued by a node also contains the following information:

- Whether the node is a ring-only or a ring-OLT node.
- If the node is an OLT, the message should indicate the following: its EPON segment, whether the OLT is primary or secondary, the status of the OLT's feeder fiber, and information about new nodes that joined the segment or nodes that were disconnected.

In the proposed architecture, the OLT requires knowledge of all the nodes in its EPON segment in order to send information about the new nodes joining the segment or any existing nodes that leave the segment. The OLT collects information about nodes in the segment through the registration protocol in the segment. A working BS sends messages about SS registration or deregistration to the OLT. Consequently, the OLT is informed about BSs joining or leaving the segment through the ONU registration or deregistration.

E. Network Operation and Management

Like ring nodes, OLT nodes store information about the shortest path and direction for each ring node in their database. Additionally, for each EPON, the OLT maintains a record of the Pri-OLT and Sec-OLT and indicates which OLT has the shortest path. Subsequently, the OLT that has shortest path is determined according to the routing mechanism and is changed according to the ring status.

In contrast to the standard RPR network, not all packets passing through the ring within our architecture are destined for nodes on the ring. Specifically, the nodes on the ring should differentiate between the packets that are sent to the ring nodes and the packets that are sent outside the ring. For packets sent outside of the ring, the ring node that functions as the best gateway for the destination should be chosen.

The first task, differentiating between the packets, can be easily achieved if the packets contain a field in their header that indicates the EPON destination of the packet. Although this is a relatively simple solution, it is not practical, as it requires the source of the packet to adhere to the network's architecture. Moreover, this solution requires a change in the upper layers of the network stack to include the EPON destination in the header of each packet.

An alternative solution involves creating OLT stores in the database for each non-ring node destination, indicating to which EPON it belongs. This solution is practical, since it only requires OLT nodes to focus on the situation. However, this method is costly and requires the OLT nodes to concentrate

on the size of the architecture, which makes the solution non-scalable. An approach to address these issues will be considered in our future work.

When the destination EPON is specified, the second task, sending the packet to the best gateway, can be easily performed by sending the packet to the OLT of the EPON that has the shortest path from the sending OLT.

The following steps manage redundant OLT nodes and support the routing mechanism in the decision to send data to any EPON segment through its Sec-OLT or Pri-OLT:

- 1) In its database, each Pri-OLT stores the MAC address of the Sec-OLT for its EPON segment.
- 2) The Sec-OLT stores MAC addresses and ring directions for its Pri-OLTs in its database.
- 3) For each of the other EPON segments, the OLT keeps two records of information for the Pri-OLT and Sec-OLT. These records include MAC addresses, path distances, ring directions, and the connection status of the OLT.
- 4) Each OLT stores sufficient information about its partner OLT, including reserved data rate, unreserved data rate, available data rate, and served streams.
- 5) The Sec-OLT sends a discover message when one of its Pri-OLTs fails.
- 6) When a ring node is not a data source or destination, it only forwards packets to OLT nodes.
- 7) The OLT behaves like a ring node when it is neither the source–destination of any data nor a gateway to its EPON segment.

In the EPON segments, the splitter is connected to the Pri-OLT and Sec-OLT on the ring. In the downlink, the splitter combines the traffic from both OLTs. Conversely, in the uplink, the splitter routes the traffic from ONUs to either the Pri-OLT or Sec-OLT, which, for each destination, requires the EPON segment to record whether it can be reached through the Pri-OLT or the Sec-OLT. Since a stream has a fixed source–destination pair, its route is specified at the setup time of the stream and is stored in the ONU. As a result, the stream route can only be changed in the case of failure, at which time the routes of all EPON segment streams will most likely be recalculated. The process of routing to one of the two OLTs is performed in one of two following ways:

- 1) For a TDM splitter, which is a mono-wavelength channel EPON, in the uplink, the ONU indicates the MAC address of the desired OLT as the next-hop address of the packet and broadcasts it to both OLTs. However, only the desired OLT will extract the packet and forward it. In the downlink, time-multiplexing is used by the splitter to combine the traffic of both OLTs, which requires time management between these OLTs.
- 2) For a dual-wavelength or multi-wavelength EPON, in the uplink, each ONU sends stream packets on the wavelength channels of the desired OLT. In the downlink, the splitter is equivalent to two splitters, each of which works on a set of wavelength channels.

IV. ROUTING PROTOCOL FOR AN RPR–EPON–WiMAX NETWORK

A. Routing in the WiMAX Part

In the WiMAX part, the routing task involves finding a route from the packet's source router to a gateway, a wireless node attached to the ONU, or vice versa. There is no routing protocol needed if a PMP WiMAX network is employed in the front end. In the case of a WiMAX mesh network, a routing algorithm similar to the delay-aware routing algorithm (DARA) in [17] can be used; however, in this case, there are two modifications:

- Rather than finding a route for every packet, the routing algorithm finds a route for streaming. Hence, the routing algorithm is executed at stream setup or when the route has to be changed due to unforeseen circumstances such as failure.
- In addition to the link delay in the route selection, link congestion is also considered.

To route a stream in a mesh WiMAX network, the following procedure is carried out:

- 1) Each link in the mesh network is assigned a weight W_{ld} according to the transfer delay of this link, as performed in [17]. In particular, a greater link delay causes a more substantial delay weight.
- 2) All possible routes that have a total delay less than or equal to the delay requirements of the stream should be indicated. The total delay is the sum of the delay of all links in the route.
- 3) Each route has delay weight W_{rd} , where

$$W_{rd} = \sum_{\forall \text{ route links}} W_{ld}. \quad (1)$$

- 4) Each route is assigned a congestion weight W_{rc} , which is related to the maximum traffic rate served by any link in the route. Accordingly, each link has a traffic rate R_t , which is the average data rate of all streams served by the link. The congestion weight W_{lc} of the link is

$$W_{lc} = R_t/C, \quad (2)$$

where C is the capacity of the link. Hence, a greater R_t indicates a higher congestion weight W_{lc} . The route congestion weight is

$$W_{rc} = \max(W_{lc} \forall \text{ route links}). \quad (3)$$

- 5) The route with the lowest weight $W = W_{rd} + W_{rc}$ is selected to route the stream. In order to give balanced roles to the delay and congestion in route selection, the delay weight should be calculated in a way that gives values in the same range as the values of the congestion weight.

Since route selection is dependent on the streams served by each link, when streams finish their work, any router in the route that discovers a more efficient modification of the route

can send a notification to the source. In this case, the source re-executes the routing algorithm for the indicated stream.

B. Routing in the Optical Part

In the optical part, i.e., the EPON and the RPR ring, the routing task involves selecting the route between the ONU in the source EPON and that in the destination EPON. Specifically, this task entails choosing one OLT in both the source and the destination EPONs as well as the path on the ring between these two OLTs.

Since the set of connections in the architecture is predetermined, the routing should work in a similar way to static light path establishment (SLE) in optical WDM networks [18]. Also, as the traffic load for each source and destination pair depends upon the traffic rates of the streams, the routing selects the route for a stream instead of finding the route for a packet.

Each link in the architecture is assigned a cost, and the route with the lowest cost is selected. Assuming that all links are free of failure and have infinite queues, the cost of the link corresponds to its delay. Also, the cost of the link is assigned in such a manner that the links with more delays are given more weight.

In addition to finding the route with the lowest delay, the routing algorithm is concerned with load balancing. Specifically, the routing algorithm aims to find a route with the least congestion among the light paths. Hence, the cost metric of the links is estimated on the basis of the links' delay and congestion. Consequently, the traffic is routed over the lightly loaded links that have minimal delay.

In each EPON segment, we need to select between two paths; however, this choice cannot be made separately from the selection of the path on the ring. The selection of an OLT that has minimum cost to the ONU in each EPON segment can result in a more expensive cost path on the ring, thus indicating that this route choice is not ideal.

As a result, all possible routes from the source ONU to the destination ONU are considered, and then the route with the lowest cost is selected. Since there are two paths in each EPON and there are two paths over the ring for each OLT source–destination pair, there are eight possible routes. Each route has an EPON cost and a ring cost. The EPON cost depends on the distance between the OLT and the splitter as well as the traffic rate of the OLT in the EPON direction. The ring cost depends on the number of hops between the selected OLTs and the congestion of each path segment.

A routing algorithm similar to that in [19] is used to select the best possible route as follows:

- 1) For each link i , calculate the link delay D_i and the congestion index of the link C_i , which is given by

$$C_i = R_{ser}/R_i, \quad (4)$$

where R_i is the data rate of the link and R_{ser} represents the total data rates of all streams served by the source node of the link. The source nodes are the OLT for EPON links and the OLT or the initial ring node for ring links.

- 2) The link cost function $Cost(i)$ is then defined as

$$Cost(i) = D_i + F_c(i), \quad (5)$$

where $F_c(i)$ is a function that has a value in the range of network delays corresponding to C_i . Thus, if D_{max} and D_{min} are the maximum and minimum link delays in the network, respectively, and, as $0 \leq C_i \leq 1$, then

$$F_c(i) = D_{min} + C_i * (D_{max} - D_{min}). \quad (6)$$

- 3) After each link is assigned a cost, Dijkstra's shortest path algorithm [20] is used to compute the lowest-cost path as the selected route.

A route for each stream is selected at stream setup time. In the case of OLT or its EPON connection failure, all traffic in the segment will be routed through the other OLT. This rerouting may result in the recalculation of routes for all streams served by the malfunctioning OLT. If the OLT functions as a Sec-OLT for more than one EPON segment, all of these segments will be affected due to failure in the Sec-OLT or in one of the Pri-OLTs.

In the case of a faulty OLT ring connection, the paths over the ring are recalculated and all traffic in the segments may be rerouted.

V. JOINT MAC PROTOCOL FOR AN RPR-EPON-WiMAX NETWORK

In this MAC protocol, we consider the PMP WiMAX in the front end and the TDM EPON. Moreover, we take into account the fact that the ONU and the WiMAX BS are integrated in a single system box (ONU-BS) by the hybrid architecture in [2].

As users are mostly served through the WiMAX part of the network, the MAC protocol should support all service types defined in the WiMAX standard, including unsolicited grant service (UGS), real-time polling service (rtPS), extended real-time polling service (ertPS, defined in 802.16e), non-real-time polling service (nrtPS), and best-effort (BE).

In this joint MAC protocol, we need to consider that the front-end capacity of the BS of the WiMAX network depends on the wireless interface of the BS and that its backhaul capacity is provided through the ONU over a fiber link. Also, the OLT has a front-end capacity that depends on the fiber link connecting the OLT to the ONUs and a backhaul capacity that the OLT can use over the rings. For both the BS and the OLT, the effective capacity is the lower of the front and backhaul capacities.

In order to preserve the comprehensiveness of the system, we assume that all streams are sourced and destined within the architecture. Hence, the MAC protocol is not concerned with the existence of the hotspot central office and its performance. Moreover, this protocol does not include the MAC of standard RPR ring nodes, as they do not affect the performance of the architecture, especially when they are not the source or destination of any data.

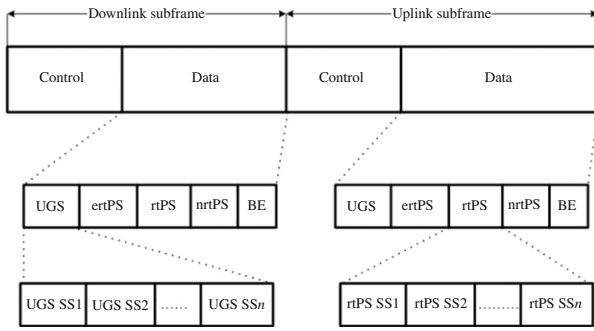

Fig. 4. WiMAX frame structure.

A. Scheduling in an RPR-EPON-WiMAX Network

The proposed scheduler for the architecture is a three-level process, as various parts of the scheduler run at the WiMAX BS, the ONU, and the OLT.

1) BS Scheduler: The proposed scheduler is service type based; it differs from the traditional WiMAX scheduler, which is a station based scheduler. In the traditional WiMAX, the data part in an uplink or downlink subframe can have a slot for each SS to transmit its data packets. Unlike a traditional WiMAX scheduler, the present proposed BS scheduler divides the data portions of downlink and uplink subframes into five subdata frames, one for each service type: UGS, ertPS, rtPS, nrtPS, and BE. Each subdata frame may have a slot for each SS. The frame structure of the proposed BS scheduler is shown in Fig. 4. Figure 4 does not give details about gaps between the downlink and the uplink and between data from different SSs, which are explained in the WiMAX standard [21].

2) ONU Scheduler: The ONU is responsible for scheduling its data in the uplink direction to the OLT during the uplink cycle. In the architecture of Fig. 1, the ONU is connected to two OLTs. Hence, part of its data is sent to the Pri-OLT and the other part is sent to the Sec-OLT. The uplink cycle is divided into two subcycles: one for the Pri-OLT and the other for the Sec-OLT. Each ONU is assigned a time slot in one or both of these subcycles, depending on which OLT serves the streams of the ONU. Within the time slot of any subcycle, the ONU schedules service types in this order: UGS, ertPS, rtPS, nrtPS, under-test, and BE. For the proposed scheduler, the uplink cycle structure in the TDM EPON is shown in Fig. 5.

3) OLT Scheduler: The OLT scheduler has two tasks: first, it schedules data to the ONUs in the downlink direction for EPON, and second, it schedules data received from the ONUs which is not destined for an OLT to its destination within the ring.

OLT Scheduler in an EPON. In the downlink direction, the cycle time is divided into two subcycles: one subcycle for each Pri-OLT and Sec-OLT. Each OLT is responsible for scheduling all the ONUs' data in the downlink cycle. The OLT assigns every ONU up to six time slots in the downlink cycle. When

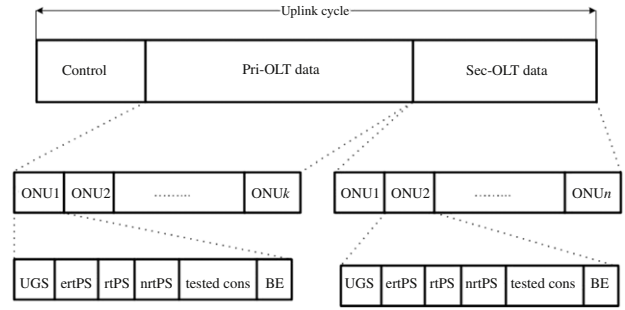

Fig. 5. Uplink cycle structure for the TDM EPON in an RPR-EPON-WiMAX network.

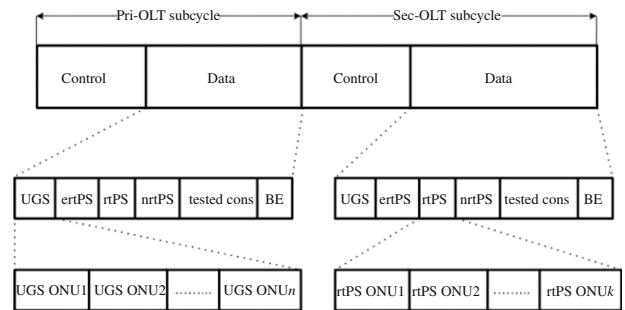

Fig. 6. Structure of the downlink EPON cycle in an RPR-EPON-WiMAX network.

the OLT schedules data packets in the downlink cycle, it first transmits UGS packets to all ONUs, then it transmits ertPS traffic. It continues to do so until it reaches the end of the subcycle or until no more data packets are left in the queue. Figure 6 shows the structure of a downlink cycle in the EPON part of the architecture depicted in Fig. 1.

OLT Scheduler Over the Ring. Over the ring, the OLT schedules data after classifying it according to the service classes defined in the RPR standard. Hence, the OLT's scheduling of ONU data over the ring is dependent on how the OLT maps the data of service types from the EPON to the RPR classes. In order to maintain consistency with the way in which traffic is treated in the WiMAX and EPON parts, the OLT can consider under-test connection traffic as FE traffic. One possible straightforward configuration maps the WiMAX service types UGS, ertPS, rtPS, nrtPS, and BE to classes A0, A1, B-CIR, B-EIR, and C of the RPR, respectively. As in the RPR standard, Class A traffic has priority over Class B traffic, which has priority over Class C traffic. Therefore, the OLT schedules these traffic classes in the order A0, A1, B-CIR, B-EIR, and C. Traffic that is under test is treated as being in the B-EIR class. Hence, the OLT schedules packets of service types from ONUs over the ring in such a way that the ONU schedules data in its own time slot. However, in this case, there is no ordering relationship between nrtPS packets and under-test connection packets.

There are several differences between ONU scheduling and OLT scheduling over the ring. First, the ONU is allocated a time slot every cycle, whereas there is no periodic scheduling

for the OLT. Second, the OLT does not receive a time slot to schedule the data over the ring, as was the case for the ONU. Rather, the OLT schedules over the ring by prioritizing MAC traffic over data traffic. Specifically, if the OLT has a single-transit queue, priority is given to the in-transit ring traffic over the station traffic. In the dual-transit queue mode, the PTQ traffic is always served first. If only the STQ has packets, the transmission queues are served while the STQ is under a certain queue threshold. Hence, the OLT schedules packets of ONU data when it does not have to serve transit traffic. Consequently, this may result in unequal gaps between periods when these packets are served.

B. Distributed Admission Control

The proposed admission control has two levels: the first level runs at the WiMAX BS and the second level runs at the OLT that connects the EPON to the RPR ring. Some streams are initially admitted by the WiMAX BS and temporarily tested to guarantee that they can run safely. Other connections need to be admitted by the OLT before they send or receive any data in the network.

1) *Admission Control at the WiMAX BS:* By considering PMP in the WiMAX, the AC for the BS can be summarized as follows:

- If the bandwidth and delay requirements of the stream cannot be satisfied by the wireless data rate of the BS, the stream is rejected.
- If the stream requirements are satisfied by both the wireless data rate and the backhaul data rate that the BS can use over the EPON through the ONU, the stream is initially accepted in the network and its performance is monitored for a period of time.
- If a stream's requirements can be satisfied by the wireless data rate of the BS but not by the backhaul data rate, it is inserted into the waiting queue and its requirements are sent to the OLT for admission.
- The QoS requirements of streams in the waiting queue are sent to both the Pri-OLT and the Sec-OLT of the segment. As will be discussed later, each stream can be admitted by any OLT.
- When the ONU/BS unit receives a new allocated bandwidth, it verifies all waiting streams and tested streams with the new backhaul data rate.
- For streams that are undergoing testing, those whose requirements are not satisfied by the new backhaul data rate are rejected. But streams whose requirements are satisfied by the new data rate are admitted into the network if they passed the testing period.
- Waiting streams are checked against the new backhaul data rate: any stream whose requirements are satisfied by the new rate is accepted to undergo testing. Streams whose requirements are not satisfied after the maximum waiting period are rejected.

The type of connection request determines whether or not both the delay and the bandwidth requirements are satisfied.

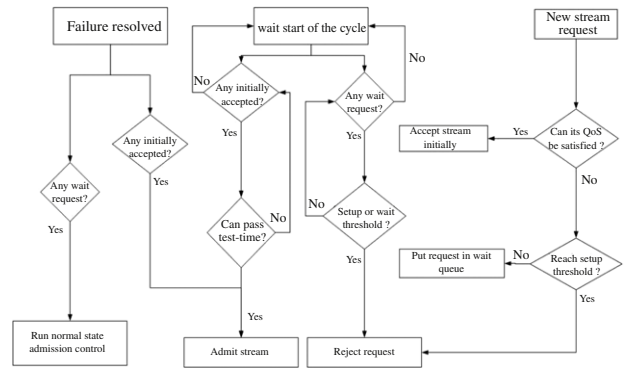

Fig. 7. OLT admission control in the case of failure.

Since the BE does not entail delay requirements or bandwidth guarantees, all BE streams can be admitted directly by the BS and cannot be forwarded to the OLT for admission. For UGS, a stream may be admitted if its mean data rate can be supported by the current system. The rtPS, ertPS, and nrtPS are admitted according to the mean data rate in order to save network bandwidth. Specifically, the nrtPS connection has no delay requirements, so only the bandwidth requirement needs to be satisfied. However, the rtPS and ertPS connections have both bandwidth and delay requirements.

2) *Admission Control at the OLT:* The OLT admits streams according to its effective data rate. The effective data rate of the OLT depends not only on the capacity of the fiber connection between the OLT and the splitter, but also on the data rate that the OLT can use on the RPR ring. In the proposed architecture, each EPON segment can be served through two OLTs. Specifically, fewer streams of the EPON segment are served through each OLT and its fiber connection. Hence, the backhaul data rate on the ring of the OLT has a more effective role in admission control. Consequently, the front-end data rate of the OLT will not be an issue during normal operation, but it can be an issue in the case of failure. As a general rule, the OLT considers both front and backhaul data rates when admitting a stream. Both the Pri-OLT and the Sec-OLT of the segment receive admission requests from all streams requiring admission by the OLT. Each stream can be admitted by either of the two OLTs.

The AC procedure differs according to the working status of the OLTs. Specifically, the OLT executes the AC procedure differently depending on whether it is in normal working conditions or in failure status.

OLT AC in the Case of Failure. This AC procedure is executed in situations where the OLT or one of its connections fails. The working OLT of the segment executes its AC similarly to that of the BS, where the data rate of the fiber connection in the EPON is considered as the front data rate and the backhaul data rate of the OLT is the data rate that it can use over the RPR ring. According to the diagram shown in Fig. 7, the streams are admitted according to the following procedure:

- If a bandwidth requirement can be reserved and a delay requirement can be satisfied, a stream is initially accepted. However, if this stream requires a new cycle time to

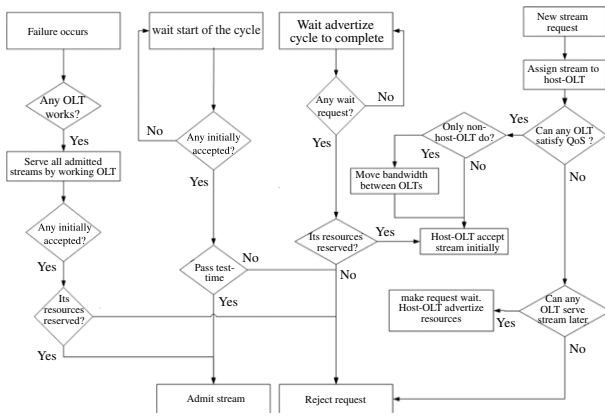

Fig. 8. OLT admission control in normal operation.

satisfy its delay requirements, these requirements are only satisfied if the cycle time can be changed so that none of the running streams are affected. For newly accepted streams, the required resources are considered as temporary, making the stream conditionally accepted at the WiMAX BS. By allocating resources as temporary, the OLT has the ability to reject the stream at a later time if it cannot maintain its resources. This scenario can occur when the OLT serves other segments and when other OLTs of this segment fail.

- Streams cannot be accepted or rejected according to the current data rate. Based on the data rate, streams that are not accepted immediately should wait in case the failure condition can be resolved. As a result, AC should be concerned with the maximum allowed setup time of streams, as they should not wait for a long period before being admitted or rejected.
- Waiting streams are checked periodically, and those that have reached their setup time threshold or have spent their maximum waiting time are rejected.
- The resources of initially accepted streams are permanently reserved when these streams are admitted into the network.
- When the failure condition is resolved, all initially accepted streams are finally admitted into the network. Waiting streams are admitted as those in the normal working state.

OLT AC in the Case of Normal Operation. When both OLTs and their connections are working normally, the front data rate of the OLT is not an issue, and streams are admitted according to the backhaul data rates of the OLTs. The two OLTs cooperate to admit streams according to the chart in Fig. 8 as follows:

1. Each stream should be assigned to the OLT, known as the host-OLT, that provides the preferred route for the stream based on the routing algorithm. In particular, the stream route provided by the host-OLT should have a maximum delay less than or equal to the delay requirement of the stream.
2. As each OLT in the segment acquires sufficient information about the other OLT, as stated in the network operation in Subsection III.E, it then can decide if the other OLT can

accept the stream, and similarly, it can make this decision for itself.

3. A stream is rejected for two reasons. First, it is rejected if it cannot be accepted by the current data rate of both OLTs and neither OLT can reserve its required resources any longer. Second, a stream is rejected if the current cycle time of the stream and the cycle time cannot be changed to meet these delay requirements without degradation in the QoS of the running streams.
4. If the current data rate of the OLTs cannot accommodate the stream but the required resources can be reserved, the host-OLT advertises the required resources. If the required resources are not reserved after the advertisement phase, the stream is rejected; otherwise, the stream is accepted, as in Step 6.
5. If a stream can only be accommodated by the current data rate of the non-host-OLT, the stream can be accepted, but its acceptance will cause the network performance to become degraded. In this case, a part of the non-host-OLT data rate is released and reassigned to the host-OLT, which accepts the stream, as in Step 6.
6. If a stream can be accommodated by the current data rate of the host-OLT or both OLTs, the stream is initially accepted by the host-OLT. However, since the stream is not accepted permanently, the probability of failure in the segment is not an issue.
7. Initially accepted streams, such as those undergoing testing, are admitted permanently after a specific waiting time.

C. Multi-level Dynamic Bandwidth Allocation (MLDBA)

The proposed DBA is a three-level algorithm: the first level runs at the WiMAX BS, the second level runs at the EPON ONU, and the third level runs at the OLT connecting the EPON to the RPR ring of the architecture.

1) Bandwidth Allocation of the BS: For the BS, bandwidth allocation is the same as the DBA of the BS in the EPON-WiMAX networks in [4]. The DBA of the BS is summarized as follows:

- Based on the values defined in the WiMAX standard, the BS sets its frame size to the value that satisfies the delay requirement of all streams served by the BS.
- The BS allocates bandwidth to service types according to its available data rate, which is the lower of the front data rate and the backhaul data rate.
- The BS assigns bandwidth according to the strict priority principle, where the priorities of service types, from highest to lowest, are UGS, ertPS, rtPS, nrtPS, and BE. In order to prevent higher priority connections from monopolizing the network, traffic policing is included in each SS. This policing forces the connection's bandwidth demand to stay within its traffic contract.
- The BS reserves a portion of its bandwidth to serve the BE traffic.

- Each UGS connection is assigned a constant bandwidth, which it receives periodically based on its fixed bandwidth requirement.
- The BS allocates requested bandwidth for each ertPS connection based on its fixed period requirement.
- The BS applies the earliest deadline first (EDF) service discipline to rtPS traffic, where packets are served according to their deadlines.
- The BS applies the weight fair queue (WFQ) service discipline for nrtPS service types.
- The remaining bandwidth for the BS is equally allocated among BE connections.

2) *Bandwidth Allocation of the ONU*: In the process of bandwidth allocation, an ONU restricts data from service types in classified queues and requests the required bandwidth for transmitting this data from the OLT. Hence, the ONU receives data from the BS(s) and from users connected directly to the ONU. Moreover, it classifies data to suitable queues on the basis of its QoS requirements. Each ONU has queues with eight different priority levels: there is one priority-level queue for each service type of UGS, ertPS, and nrtPS, as well as BE service types of the BS. For rtPS, the ONU has two priority-level queues: one for packets with deadlines in the next cycle and another for packets whose deadlines are not imminent. Finally, the other two priority-level queues are for connections that are undergoing testing and new connections that cannot be accepted by the BS and need to be admitted by the OLT.

In the proposed architecture, the ONUs are connected to two OLTs. Each set of ONU streams is served through one of the two OLTs: hence the ONU should have two sets of priority-level queues, one for each OLT. In addition, the ONU stores a variety of information for each OLT, including the total data rates of all UGS connections, the total minimum data rates of all ertPS connections, and the total mean data rates of all rtPS connections. This information is updated when a new connection is admitted by the BS and when one of the running connections completes service.

The ONU sends a bandwidth request to each OLT. Specifically, the bandwidth request is sent in a report message. Hence, the ONU sends two report messages: one to each OLT. The report messages are broadcast to both OLTs, and each OLT receives the message destined for its MAC address. In addition to containing the current data size for the ONU, the report message indicates the predicted size of the arriving rtPS and ertPS data streams, as explained in [4].

Each OLT grants bandwidth to the ONU, which divides the bandwidth among priority-level queues by the scheduler, as previously explained in Subsection V.A.2.

3) *Bandwidth Allocation of the OLT*: The OLT BA has two main parts: the first allocates bandwidth among the ONUs and second reserves the required bandwidth on the ring.

Bandwidth Allocation of OLT in EPON. To allocate bandwidth among the ONUs, each OLT, primary and secondary, executes the bandwidth allocation algorithm as follows. First of all, the cycle time of the EPON segment is set to satisfy the required

frame size of all BSs attached to ONUs in the segment. At the same time, the data rate corresponding to this cycle time should be sufficient for serving all streams in the segment. The cycle time is divided into two subcycles, one for each OLT:

$$T_{\text{EPON_cycle}} = T_{\text{Pri-OLT_sub_cycle}} + T_{\text{Sec-OLT_sub_cycle}}, \quad (7)$$

where each subcycle of $T_{\text{Pri-OLT_sub_cycle}}$ and $T_{\text{Sec-OLT_sub_cycle}}$ satisfies both the delay and the bandwidth requirements for streams served through its normally functioning OLT. Thus, the length of each subcycle is related to the frame sizes required by the streams that are served by this OLT:

$$T_{\text{OLT_sub_cycle}} = \begin{cases} \eta * \min(F_l) & \text{if OLT work} \\ 0 & \text{if OLT fail,} \end{cases} \quad (8)$$

where η is a constant that depends on the ratio between the BS data rate and the rate for the fiber connection of the OLT.

After setting the cycle time, the OLT allocate bandwidth as follows:

- First, the OLT assigns the basic bandwidth part for each ONU. This part is the sum of the bandwidth requested for UGS, the minimum required bandwidth for ertPS, and the bandwidth required to send rtPS packets with deadlines in the next cycle.
- Then, the OLT tries to satisfy the bandwidth requests for ertPS, rtPS, the predicted ertPS and rtPS, nrtPS, interim connections, new connections, and BE requests.
- After assigning all requests to all queues, any remaining bandwidth is divided among the ONUs according to their total request weight.

The OLT allocates bandwidth among the ONUs according to its available capacity. Specifically, the available bandwidth consists of the minimum of the front bandwidth, which is based upon the capacity of the fiber that connects the OLT to the ONUs, and the bandwidth that the OLT can allocate over the RPR ring network.

Bandwidth Allocation of an OLT Over the Ring. According to network operation as described in Subsection III.E, when a new stream needs to be established in an EPON segment, the details of the stream are sent to both the Pri-OLT and the Sec-OLT. Hence, both OLTs contain sufficient information about all streams run in the segments. According to this information, each OLT allocates part of its total capacity for the EPON segment on the ring network. In general, the OLTs reserve bandwidth on the ring as follows:

- Each OLT tries to reserve bandwidth on the ring for non-fairness eligible (NFE) traffic, as no reservation is required for fairness eligible (FE) traffic. FE traffic is served through the amount of unreserved bandwidth that the OLT can use.
- In order to prevent starvation of FE traffic, the OLTs reserve a maximum of $(1 - \delta)$ of the ring capacity, where δ of the ring capacity is left for FE traffic.

- Each OLT reserves C_{OLT_min} on the ring, which is

$$C_{OLT_min} = \min(B_{OLT_req_min}, W_{OLT} * C_{Ring}), \quad (9)$$

where $B_{OLT_req_min}$ is the sum of the bandwidths required for the A0, A, and B_{CIR} classes. These bandwidths are mapped to the bandwidth requested for UGS, the minimum bandwidth required for ertPS, and the bandwidth required for sending packets with a short deadline in rtPS queues. The OLT weight (W_{OLT}) is calculated as the ratio of the required OLT bandwidth to the total required bandwidth:

$$W_{OLT} = \frac{B_{OLT_req_min}}{\sum_{\text{all OLTs}} B_{OLT_req_min}}. \quad (10)$$

Here, C_{Ring} is the total data rate available over the ring.

- The remaining data rate available (C_{Ring_rem}) over the ring is the sum of the unreserved data rate and the unused bandwidth of all OLTs:

$$C_{Ring_rem} = C_{Ring_un_resv} + \sum_{\text{all OLTs}} B_{OLT_unused}. \quad (11)$$

This is divided among the OLTs to serve FE traffic according its weight for the OLT; hence

$$C_{OLT_FE} = \frac{B_{OLT_FE_Size} * C_{Ring_rem}}{\sum_{\text{all OLTs}} B_{OLT_FE_Size}}, \quad (12)$$

where $B_{OLT_FE_Size}$ is the size of all FE traffic of the OLT.

- The total bandwidth for each OLT is

$$B_{OLT} = C_{OLT_min} + C_{OLT_FE}. \quad (13)$$

- The total capacity (C_{EPON}) allocated for each EPON segment over the RPR ring is the sum of bandwidths allocated to its Pri-OLT and Sec-OLT:

$$C_{EPON} = B_{Pri-OLT} + B_{Sec-OLT}. \quad (14)$$

- The C_{EPON} on the ring is composed of αC_{EPON} due to the Pri-OLT and $(1 - \alpha)C_{EPON}$ due to the Sec-OLT. The α ratio depends upon the traffic serviced by each OLT; this ratio can be changed in the case of failure, as some traffic may be rerouted between OLTs.

VI. PERFORMANCE EVALUATION

This section will use simulation experiments to evaluate the performance of the proposed architecture implementing the suggested MAC protocol. Furthermore, the experiments will verify the effectiveness of the proposed MAC protocol. In the simulation, we make the following assumptions:

- (1) Each SS is equidistant from the BS. Each SS has a line of sight with the BS. All wireless channels are error free.
- (2) In the EPON segments, each ONU is equidistant from the OLT(s). The OLTs are equally spaced over the ring, and the EPON segments are equally distributed around the ring.

- (3) The RPR standard ring nodes do not reserve any bandwidth as they are neither the source nor the destination of data.
- (4) The arrival and the lifetime of service flows occurs randomly with uniform distribution throughout the simulation.

Specifically, we will test the system performance in two scenarios:

- (1) Regular operation. In this scenario, the sum of the required data rates for all running streams does not exceed the system capacity. This experiment aims to test the connection level of the QoS enforcement capability for the proposed MAC protocol. Particularly, we hypothesize the following. First, the maximum delay of any connection is less than the maximum latency constraint of the connection. Second, the average throughput of any connection should be greater than or equal to its minimum reserved data rate.
- (2) Overloaded network. In this scenario, the sum of the required data rates for incoming streams can exceed the system capacity. Accordingly, this experiment aims to test the performance of the admission control for the proposed MAC protocol. In order to further test the effectiveness of the admission control, we will also change the delay requirements of the incoming streams while maintaining the required data rates to measure the effect of changing the frame duration and cycle time. Specifically, we hypothesize the following. First, the proposed MAC protocol demonstrates effective bandwidth utilization. Second, stream rejection can be minimized by changing the frame duration and cycle time according to the delay requirements.

A. Unintegrated and Unprotected System (UN-IRPEW)

In order to highlight the advantages of the proposed architecture and MAC protocol, we also simulated another system that we refer to as the unintegrated and unprotected RPR-EPON-WiMAX (UN-IRPEW) system. This UN-IRPEW system merely implements the standard specifications of the RPR, EPON, and WiMAX network without any integration among them. Moreover, the architecture of the UN-IRPEW system does not implement the protection scheme. In general, the key properties of this UN-IRPEW system include the following:

- (1) Each EPON segment is connected to the ring network through only one OLT.
- (2) Each MAC protocol, RPR, EPON, or WiMAX, is run separately, and the MAC protocols of the EPON and RPR serve WiMAX streams in the same way they serve the data from individual users.
- (3) All streams are admitted through the WiMAX part only and on a first-come-first-served basis.
- (4) In the WiMAX network, the frame duration cannot be changed to satisfy the delay requirements of a connection.
- (5) The WiMAX and EPON schedulers are station based schedulers.
- (6) This system does not consider the *light-load penalty phenomenon*.

TABLE I
QoS PARAMETER SETTINGS FOR THE RPR-EPON-WIMAX
SIMULATION

| | UGS | ertPS | rtPS | nrtPS | BE |
|---------------------------|-----|-------|------|-------|-----|
| Offered rate (Mbps) | 1.0 | 1.4 | 2.3 | 1.5 | 2.3 |
| Max sustained rate (Mbps) | 0.5 | 1.0 | 1.0 | 1.0 | 1.0 |
| Min reserved rate (Mbps) | 0.5 | 0.5 | 0.5 | 0.5 | N/A |
| Max latency (s) | 0.6 | 0.4 | 0.15 | N/A | N/A |

B. Simulation Model

To simulate the proposed architecture and the suggested MAC protocol, we used NS-2 simulation software [22]. Specifically, we used the NS-2 WiMAX module developed by The National Institute of Standards and Technology [23] as the basis for our developed WiMAX module. Also, we created modules to simulate both the EPON and the RPR in NS-2. To obtain the required measures, we simulated a network similar to Fig. 1 for the proposed architecture, referred to as integrated and protected RPR-EPON-WiMAX (IRPEW). In this network, each segment is served through two OLTs, but no OLT serves more than one segment. In the other architecture, named UN-IRPEW, each EPON segment is served through only one OLT.

Each network consists of four EPON segments connected by an RPR ring that has ten nodes. Specifically, each EPON segment has four ONU/BSs connected to OLT(s) through 10 Gb/s fiber optic connections. In the WiMAX section of these networks, each BS serves four SSs and each SS has seven UGS, eight ertPS, seven rtPS, nine nrtPS, and five BE connections. Although the proposed MAC protocol includes both uplink and downlink directions, in the simulation model, we test only the uplink part, which is the most critical; hence, all connections are in the uplink direction, originating from each SS.

In the simulation, WiMAX PHY is OFDM-TDMA, and we use packets with a fixed size of 320 bytes. The QoS parameter settings of the service types are listed in Table I.

At the beginning of the simulation, the frame duration of the WiMAX network and the cycle time of the EPON are set to 5 ms and 20 ms, respectively. In the proposed system, the ratio between the frame duration and the cycle length is maintained if the frame duration is changed to meet the delay requirement.

The NS-2 built-in exponential traffic model is applied to simulate the traffic flow offered to all connections, except for UGS ones, which are simulated as CBR models. The run time for each simulation experiment is 15 s, and each experiment runs five times. The results are taken as the average outcome of these runs.

C. Results and Discussion

1) *Regular Operation*: In this scenario, we run the simulation to test the compliance of measured service parameters for each service type with predefined QoS parameters. Specifically, for two service types, UGS and rtPS, we measure the average throughput and compare the results with the minimum data rate for each service type. Moreover, we measure the average

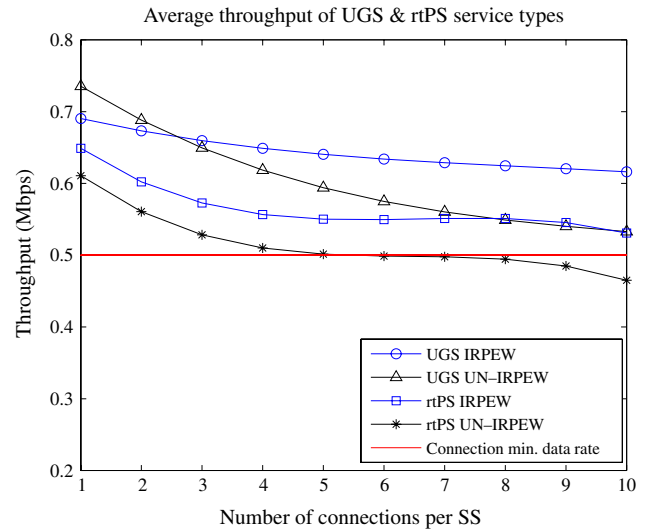

Fig. 9. (Color online) Average throughput of UGS service type in regular operation.

delay in comparison to the maximum latency, and we assess the maximum delay of UGS to ensure that no packet is delayed more than its allotted limit. Finally, the network utilization is measured to indicate the extent to which network resources are used efficiently.

Figure 9 illustrates the average throughput of the UGS, the highest priority service type, and the rtPS, the third-level priority service type.

- (1) IRPEW provides more throughputs for service types than UN-IRPEW. However, when the network has a light load, the UGS throughput in IRPEW is slightly lower than that of UN-IRPEW; this discrepancy is due to the overhead introduced by IRPEW.
- (2) IRPEW is still capable of ensuring the minimum reserved traffic rate of the rtPS and UGS connections. As demonstrated in Fig. 9, the throughput curves of both service types in IRPEW are maintained above the minimum reserved traffic rate for each service type. However, this is not the case with UN-IRPEW, as the throughput of rtPS falls under the minimum required data rate.

Some observers may believe that IRPEW maintains the required data rates for UGS and rtPS but not for other service types. However, as Fig. 10 demonstrates, IRPEW utilizes the network bandwidth more efficiently than UN-IRPEW. Hence, even though IRPEW does not necessarily maintain the required data rates for other service types, it nevertheless provides the best possible service. Moreover, Fig. 10 proves that although IRPEW introduces additional overhead, especially in the scheduler, since many gaps are inserted between the data, it nevertheless improves the efficiency of network resource utilization.

Figure 11 shows the delays of the UGS service type, and Fig. 12 illustrates the average delay of the rtPS type. Although the average delays of UGS in both the IRPEW and UN-IRPEW systems are below the maximum latency of the service type, the maximum delay in UN-IRPEW exceeds this

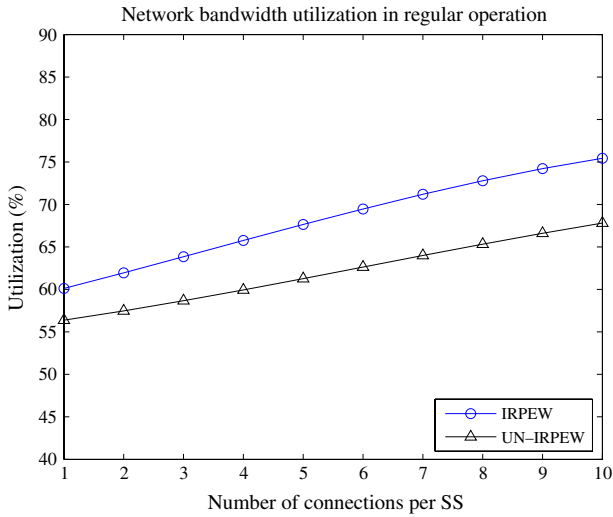

Fig. 10. (Color online) Network bandwidth utilization in regular operation.

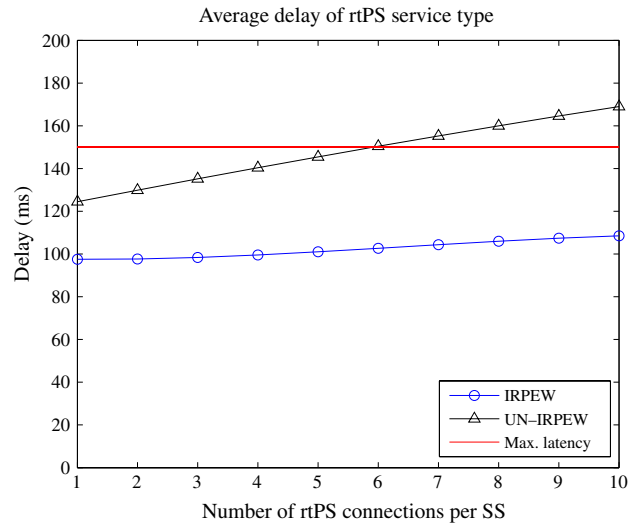

Fig. 12. (Color online) Average delay of rtPS service type in regular operation.

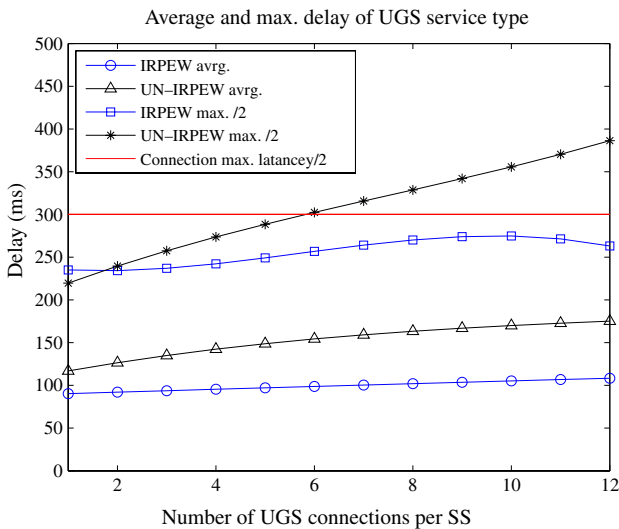

Fig. 11. (Color online) Delay of UGS service type in regular operation.

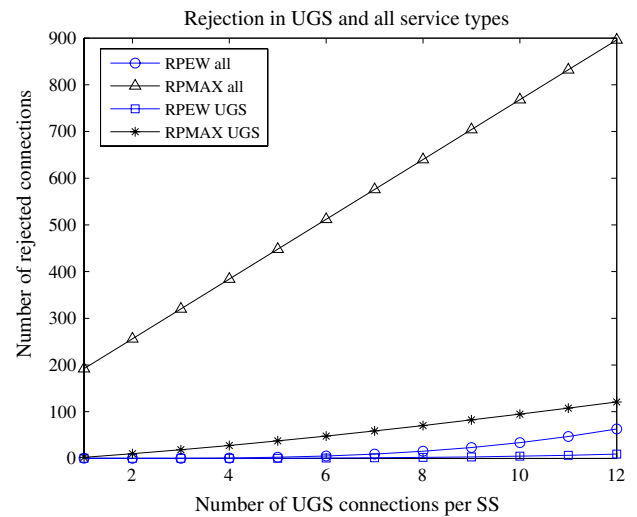

Fig. 13. (Color online) Connection rejection in loaded operation.

limit. As a result, some packets exceed the permitted delay for this service, potentially rendering them useless. Figure 12 demonstrates that, unlike UN-IRPEW, IRPEW keeps the average delay of rtPS under its limit. Hence, after a specific point of network loading, UN-IRPEW does not satisfy the QoS requirement for rtPS, while IRPEW satisfies this QoS requirement over a wide range of network loads. Moreover, the graph shows that, while IRPEW can still satisfy the QoS requirement for increased network loading, the delay in IRPEW increases slightly with a greater load. Therefore, this simulation scenario has verified the hypothesized performance for IRPEW.

2) *Loaded Network*: This scenario evaluates the ability of the MAC protocol to manage network resources even when the incoming traffic exceeds the allowed data rate of the

network. Specifically, we measured how the MAC protocol admits streams in the network in order to utilize the network resources efficiently. Hence, we measured the rejection of all service types and rejection in the most important service types in terms of the number of incoming connection changes. Also, we determined the network bandwidth utilization according to the admitted connections. Finally, we assessed the rejected connections that resulted from delay requirements in order to verify the benefits of changing the frame duration and/or the cycle time to meet delay requirements.

Figure 13 shows the number of rejected connections increasing as the required data rate of streams increases. Specifically, the graph focuses on UGS, the service type with highest priority, to verify how the two systems manage the priorities of various service types. The figure demonstrates that under the same conditions of network loading, IRPEW

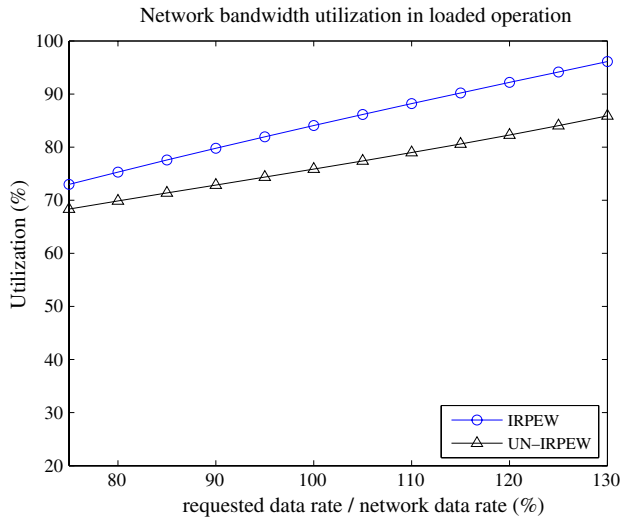

Fig. 14. (Color online) Network bandwidth utilization in loaded operation.

admits more UGS streams than UN-IRPEW. Moreover, IRPEW does not admit UGS streams on account of other service types; thus, IRPEW admits more streams of all service types. As a result, IRPEW uses network bandwidth more efficiently than UN-IRPEW, as illustrated in Fig. 14, which visualizes network bandwidth utilization under the same network loading as that in Fig. 13.

Figure 15 shows network rejection when the required data rate of the incoming streams is kept within the available bandwidth of the network but the delay requirement changes. Specifically, the graph measures the number of rejected connections as the required delay limit changes compared with the length of the cycle time of EPON. In general, UN-IRPEW rejects many more streams than IRPEW. UN-IRPEW may reject a stream because its delay requirement cannot be satisfied even though the available bandwidth can accommodate this stream. However, IRPEW can change the cycle and/or frame setting to satisfy the delay requirement of the stream.

3) Light-Load Penalty: Since the proposed MAC protocol is based on priority queues, it is subject to the *light-load penalty phenomenon* [24], where low-priority queues experience a substantial delay when a light load is served by the network. However, the proposed MAC protocol takes this phenomenon into account by predicting the incoming traffic of time-sensitive service types. Hence, low-priority service types do not have to wait a long time to be served. Figure 16, which presents the delays of nrtPS and BE service types, the lowest priorities in the system, shows that the average and maximum delay of both types increase as the network load changes from 1% to 38% of the total network load. Hence, the proposed MAC protocol does not suffer from the light-load penalty phenomenon. Moreover, Fig. 16 indicates the ability of the proposed MAC protocol to avoid BE traffic starvation. After a specific point of network loading, delays of BE traffic go below that of nrtPS traffic, which is a higher priority. This phenomenon results from the fact that the MAC protocol

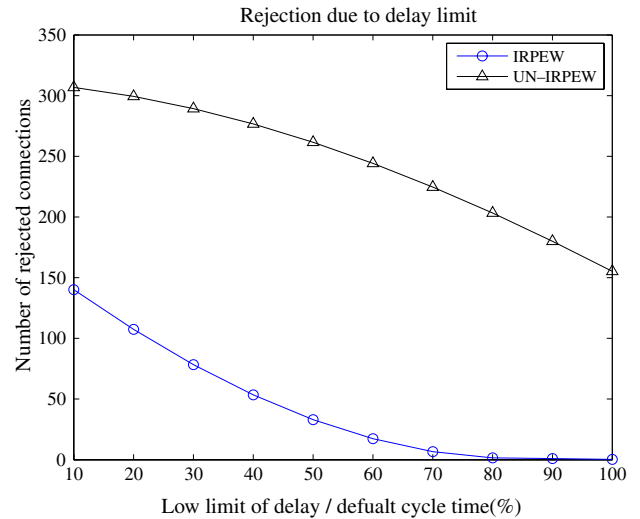

Fig. 15. (Color online) Rejection due to violation of delay limits.

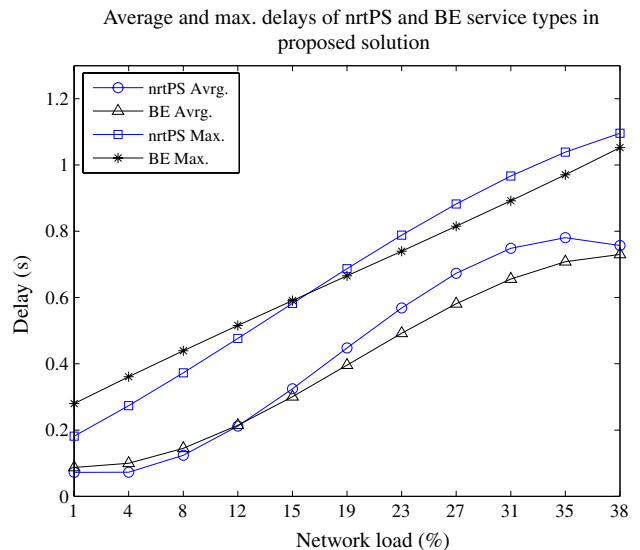

Fig. 16. (Color online) Delays of nrtPS and BE service types.

reserves a quota of system bandwidth for BE traffic. If the delays of BE are required to be higher than those of nrtPS, this phenomenon can be controlled by decreasing the BE quota.

VII. CONCLUSION AND FUTURE WORK

In this work, we have proposed an architecture for an RPR-EPON-WiMAX hybrid network and suggested a routing algorithm and a MAC protocol, including a scheduler, DBA, and distributed admission control, for the proposed architecture. We conclude that this is a suitable architecture for such a hybrid network. In addition, we emphasized that all parts of the architecture should be at the same level of reliability. The suggested routing mechanism considers

the conditions over the entire network while selecting the route through both the WiMAX and optical parts in a way that minimizes the delay and balances the load. The MAC protocol aims at compatibility with this architecture in order to maximize its performance. This work examined an effective distribution of MAC protocol functionalities over the parts of the architecture. Also, it examined the cooperation among MAC protocol components as well as their cooperation with the routing protocol for the architecture. We conclude that this MAC protocol's flexibility in setting its parameters results in an efficient use of network resources. In the proposed solution, only the PMP mode of the WiMAX network and the TDM EPON were considered. Solutions involving a mesh WiMAX network and a WDM EPON need to be studied, especially since network management and resource allocation is different for this solution. Specifically, this solution could be more suitable for rural regions. In this work, the performance of the proposed solution was evaluated through simulation, but, in the future, a mathematical analysis of this solution could profitably be undertaken.

REFERENCES

- [1] F. Davik, M. Yilmaz, S. Gjessing, and N. Uzun, "IEEE 802.17 resilient packet ring tutorial," *IEEE Commun. Mag.*, vol. 42, no. 3, pp. 112–118, Mar. 2004.
- [2] G. Shen, R. Tucker, and C.-J. Chae, "Fixed mobile convergence architectures for broadband access: Integration of EPON and WiMAX," *IEEE Commun. Mag.*, vol. 45, no. 8, pp. 44–50, Aug. 2007.
- [3] K. Yang, S. Ou, G. Ken, and H.-H. Chen, "Convergence of ethernet PON and IEEE 802.16 broadband access networks and its QoS-aware dynamic bandwidth allocation scheme," *IEEE J. Sel. Areas Commun.*, vol. 27, no. 2, pp. 101–116, Feb. 2009.
- [4] A. Ahmed and A. Shami, "A new bandwidth allocation algorithm for EPON-WiMAX hybrid access networks," in *GLOBECOM*, 2010, pp. 1–6.
- [5] Y. Luo, S. Yin, T. Wang, Y. Suemura, S. Nakamura, N. Ansari, and M. Cvijetic, "QoS-aware scheduling over hybrid optical wireless networks," in *Nat. Fiber Optic Engineers Conf.*, Mar. 2007, NThB1.
- [6] Y. Lou, T. Wang, S. Weinstein, M. Cvijetic, and S. Nakamura, "Integrating optical and wireless services in the access network," in *Optical Fiber Communication Conf. and Expo. and the Nat. Fiber Optic Engineers Conf.*, Anaheim, CA, Mar. 2006, NThG1.
- [7] S. Sarkar, S. Dixit, and B. Mukherjee, "Hybrid wireless-optical broadband-access network (WOBAN): A review of relevant challenges," *J. Lightwave Technol.*, vol. 25, no. 11, pp. 3329–3340, Nov. 2007.
- [8] W. Shaw, S. Wong, N. Cheng, and X. Zhu, "Hybrid architecture and integrated routing in a scalable optical-wireless access network," *J. Lightwave Technol.*, vol. 25, no. 11, pp. 3443–3451, Nov. 2007.
- [9] P.-H. H. Ahmad, R. Dhaini, and X. Jiang, "WiMAX-VPON: A framework of layer-2 VPNs for next-generation access networks," *J. Opt. Commun. Netw.*, vol. 2, no. 7, pp. 400–415, July 2010.
- [10] F. J. Alsolami and P.-H. Ho, "A novel two-level hierarchical scheduling scheme for integrated WiMAX and EPON," in *ICS 2008*, DSpace FC University, Jan. 2009.
- [11] Y. Yan, H. Yu, H. Wang, and L. Dittmann, "Integration of EPON and WiMAX networks: Uplink scheduler design," *Proc. SPIE*, vol. 7137, 713704, 2008.
- [12] I.-S. Hwang, J.-Y. Lee, C.-W. Huang, and Z.-D. Shyu, "Advanced dynamic bandwidth allocation and scheduling scheme for the integrated architecture of EPON and WiMAX," in *10th Mobile Data Management: Systems, Services and Middleware (MDM '09)*, 2009, pp. 655–660.
- [13] T. Tang, G. Shou, Y. Hu, and Z. Guo, "Performance analysis of bandwidth allocation of convergence of WiMAX and EPON," in *Network Security, Wireless Communications and Trusted Computing (NSWCCTC '09)*, 2009, vol. 1, pp. 662–665.
- [14] M. Maier and M. Herzog, "STARGATE: The next evolutionary step toward unleashing the potential of WDM EPONs," *IEEE Commun. Mag.*, vol. 45, no. 5, pp. 50–56, May 2007.
- [15] F. P. N. Ghazisaidi and M. Maier, "SuperMAN: Optical-wireless integration of RPR and WiMAX," *J. Opt. Netw.*, vol. 8, no. 3, pp. 249–271, Mar. 2009.
- [16] M. P. M. M. Reisslein and M. Maier, "WDM Ethernet passive optical networks," *IEEE Commun. Mag.*, vol. 44, no. 2, pp. 518–525, Feb. 2006.
- [17] S. Sarkar, H. Yen, S. Dixit, and B. Mukherjee, "DARA: Delay-aware routing algorithm in a hybrid wireless-optical broadband access network (WOBAN)," in *IEEE Int. Conf. on Communications (ICC)*, Glasgow, Scotland, June 2007, pp. 2480–2484.
- [18] G. Ramesh and S. Vadivelu, "Reliable routing and wavelength assignment algorithm for optical WDM networks," *Eur. J. Sci. Res.*, vol. 48, no. 1, pp. 85–96, 2010.
- [19] G. Ramesh and S. Vadivelu, "A reliable and fault-tolerant routing for optical WDM networks," *Int. J. Comp. Sci. Inf. Secur.*, vol. 6, no. 2, pp. 048–054, 2009.
- [20] <http://www-b2.is.tokushima-u.ac.jp/~ikedas/suuri/dijkstra/Dijkstra.shtml>.
- [21] "IEEE Standard for Local and Metropolitan Area Networks—Part 16: Air Interface for Fixed Broadband Wireless Access Systems," *IEEE Std 802.16-2004*, 2004.
- [22] <http://www.isi.edu/nsnam/ns/>.
- [23] <http://www.antd.nist.gov/seamlessandsecure/toolsuite.html>.
- [24] G. Kramer, B. Mukherjee, S. Dixit, and Y. Ye, "Supporting differentiated classes of service in EPON-based access network," *J. Opt. Netw.*, vol. 1, no. 8/9, pp. 280–298, 2002.



Abdou R. A. Ahmed received his B.Sc. degree in Electrical and Computer Engineering from Assuit University, Assuit, Egypt, in 1998, and his M.Sc. in Electrical and Computer Engineering from South Valley University, Aswan, Egypt, in 2004. He is currently working toward his Ph.D. degree in Electrical and Computer Engineering at the University of Western Ontario. His research interests focus on access networks, more specifically on optical/wireless

broadband access networks.

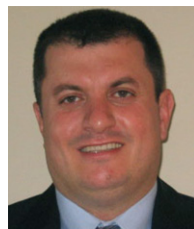

Abdallah Shami (M03, SM09) received his B.E. degree in Electrical and Computer Engineering from the Lebanese University, Beirut, Lebanon, in 1997, and his Ph.D. degree in Electrical Engineering from the Graduate School and University Center, City University of New York, New York, USA, in September 2002. He then joined the Department of Electrical Engineering at Lakehead University, Thunder Bay, Canada, as an Assistant Professor. Since

July 2004, he has been with the University of Western Ontario, London, Canada, where he is currently an Associate Professor in the Department of Electrical and Computer Engineering. His current research interests are in the area of wireless/optical networking.